

Before you begin, read all warnings and installation instructions thoroughly.

Safety & Warnings

- Install in accordance with the National Electric Code and local regulations.
- This product is intended to be installed and serviced by a qualified, licensed electrician.
- DO NOT connect tape directly to 120VAC power.
- To meet the tape light ETL Listing certification, tape light must be powered with a compatible Class 2 DC constant voltage LED driver (power supply).
- Each LED driver is unique and may require a proper load derating, which is dependent to the installed ambient temperature environment. Refer to each driver specification sheet for full power ratings & load deratings.
- Do not power tape light while attached to plastic spool or tightly coiled. Excess heat may melt the spool and/or cause damage to the tape.
- Do not install tape light in direct sunlight.
- Packaging label will indicate if the enclosed tape light model is approved for wet location installation. Do not submerge wet location tape in liquids. Do not install near chemically treated water or salt water.
- Ensure applicable wire is installed between driver, fixture, and any controls in between. When choosing wire, factor in voltage drop, amperage rating, and type (in-wall rated, wet location rated, etc.). Inadequate wire installation could overheat wires, and cause a fire.
- Tape light, attached wire leads, and additional extension cables, connectors, etc., are not rated for in-wall installation unless otherwise noted. Connectors have a Class 2 amp limit unless otherwise noted.
- Tape light must be handled with care. Excessive handling, bending, and pressure may damage the product, voiding the warranty.
- Each tape light has a different power consumption rating and maximum run length that must be individually wired to a compatible low voltage (PWM) control or DMX decoder. Refer to the tape light packaging label or specification sheet for further technical information.

Tape Light Handling

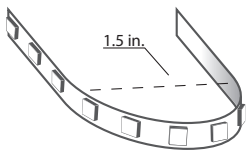

Do not bend LED tape light to a diameter less than 1.5 inches.

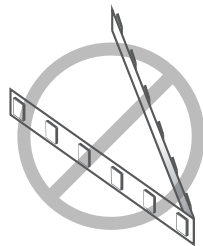

Do not fold or crease LED tape light.

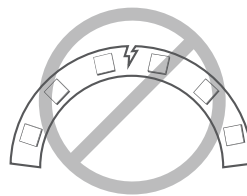

Do not bend LED tape light on a horizontal plane.

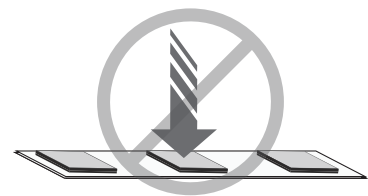

Do not put excessive pressure on surface of tape light (e.g. glass/acrylic panes etc.).

Installation

Prior to installation, ensure all components are a compatible system. Configure and pre-test your LED system prior to permanent installation to ensure all components are operating correctly. Install in accordance with the NEC and local regulations.

1. Turn power OFF at the main breaker before servicing or installing this product.
2. Determine a well-ventilated, accessible location for the driver, RGB controller or other accessories (DMX decoder, etc.). Ensure applicable wire is installed between driver, fixture and any controls between.
3.
 - a. *Indoor Tape* - Prior to cutting tape light, refer to 'RGB CLICKTIGHT Connectors' on page 2 for connection information.
 - b. *Wet Location Tape* - Cut tape at the scissors icon and seal all exposed sections of tape with silicone sealant and end caps. See 'Mounting - Wet Location Tape Light' on page 2 for sealing instructions.
4. Mount tape to desired surface. See 'Mounting' on pages 1 & 2. Attach additional wiring and accessories to tape leads using applicable wire nuts, DC connectors, etc.
5. Harness all wires with a plastic cable staple/wire harness, starting 2-4 inches from tape and every 4 feet thereafter. This will ensure connections do not detach from tape from excess pressure.
6. Connect compatible drivers and RGB lighting controls. See component installation guides for detailed wiring connections.
7. Review the full system. Ensure all polarities are correct and connections are secured.
8. Turn power ON at the main breaker. If system is not functioning properly, turn power OFF and see 'Troubleshooting.'

Mounting

Indoor Tape Light

1. Install on a finished, smooth surface, away from direct sunlight. Clean surface and let dry.
2. If utilizing tape light connectors, see page 2 prior to continuing. Remove adhesive paper from the tape light to expose 3M™ adhesive.
3. Adhere tape to surface, working one end to the other to prevent air pockets and raised sections. Utilize a clean rag between skin and tape to resist oil transfer from skin to LEDs. Continue following the remaining installation instructions.

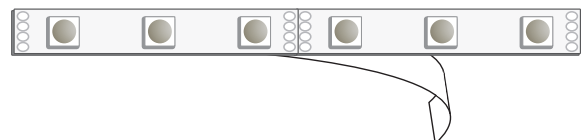

Mounting

Wet Location Tape Light

Wet location tape includes mounting clips and hardware to harness tape light to a desired surface. Wet location splice connectors and end caps are also included. Utilize male and female wet location connectors to connect various cut lengths in series. Ensure not to exceed the maximum run limit of the tape light. Do not submerge wet location tape in liquids. Do not install near chemically treated water or salt water. Do not install in direct sunlight.

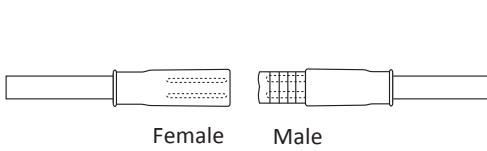

Female Male

Utilize female and male wet location connectors to attach cut sections of wet location tape in series.

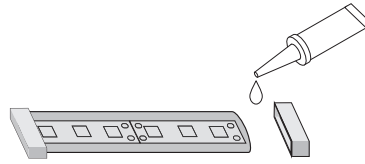

All cut points must be sealed with silicone adhesive (not included), and wet location end caps.

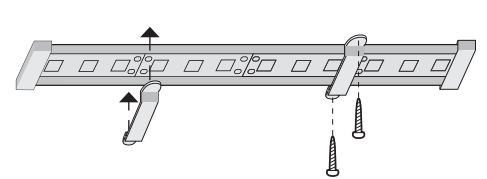

Mount with included mounting clips and screws. Silicone adhesive can also be utilized to mount tape to surfaces.

RGB CLICKTIGHT™ Connectors

Cutting Tape Light

These instructions apply only to RGB CLICKTIGHT Connectors (does not apply to solid color CLICKTIGHT Connectors). Never cut tape attached to a live circuit.

1. Cut the tape at the line indicated with the scissors icon.

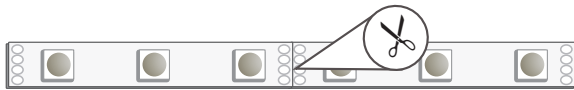

4. Close the CLICKTIGHT latch to ensure connection.

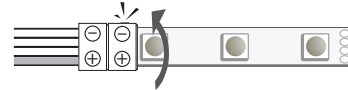

2. Open the CLICKTIGHT latch and note the +/- polarity markings.

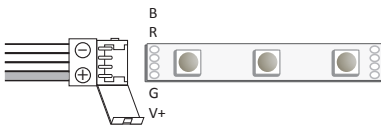

5. When ready for mounting, peel off the 3M adhesive backing of the tape and tear off along the connector tray edge.

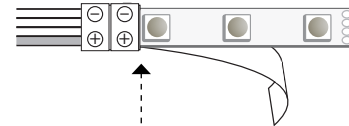

3. Firmly insert the tape light into the connector tray with the 3M adhesive backing still intact to the tape. Ensure the contact/solder points of the tape are directly underneath the metal placement tabs of the connector. *CLICKTIGHT connectors have a Class 2 amperage limit.

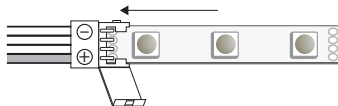

*All CLICKTIGHT accessories have a Class 2 amperage limit: 60W/5A @ 12VDC; 96W/4A @ 24VDC. CLICKTIGHT connectors are not compatible with wet location tape light. See 'Troubleshooting' for tape light connector issues.

See next page for example system diagrams.

System Diagrams

The following diagrams are provided as example system designs. Installations larger than one spool of tape light require a DMX system or RGB Zone Controller system (zone system not picture below). Contact technical support or see the product web page for additional system examples. Always review each component installation guide for detailed and up-to-date wiring instructions.

RGB Plug-In Adapter System

For small-scale RGB installations

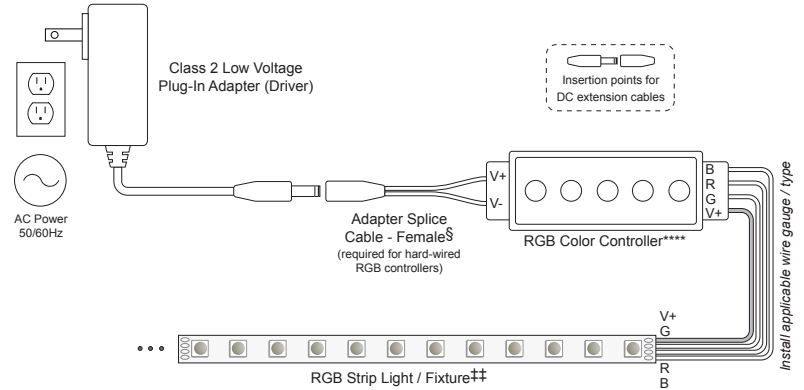

RGB Hard-Wire System

For small-scale RGB installations

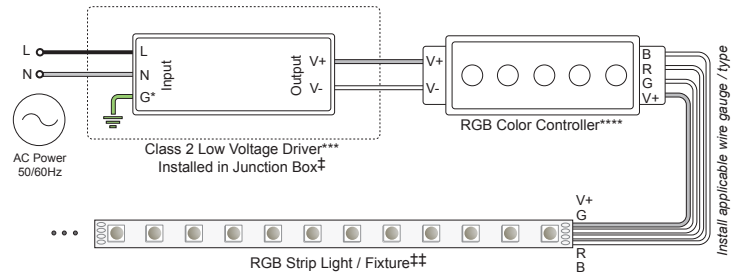

DMX System

For small or large-scale RGB installations

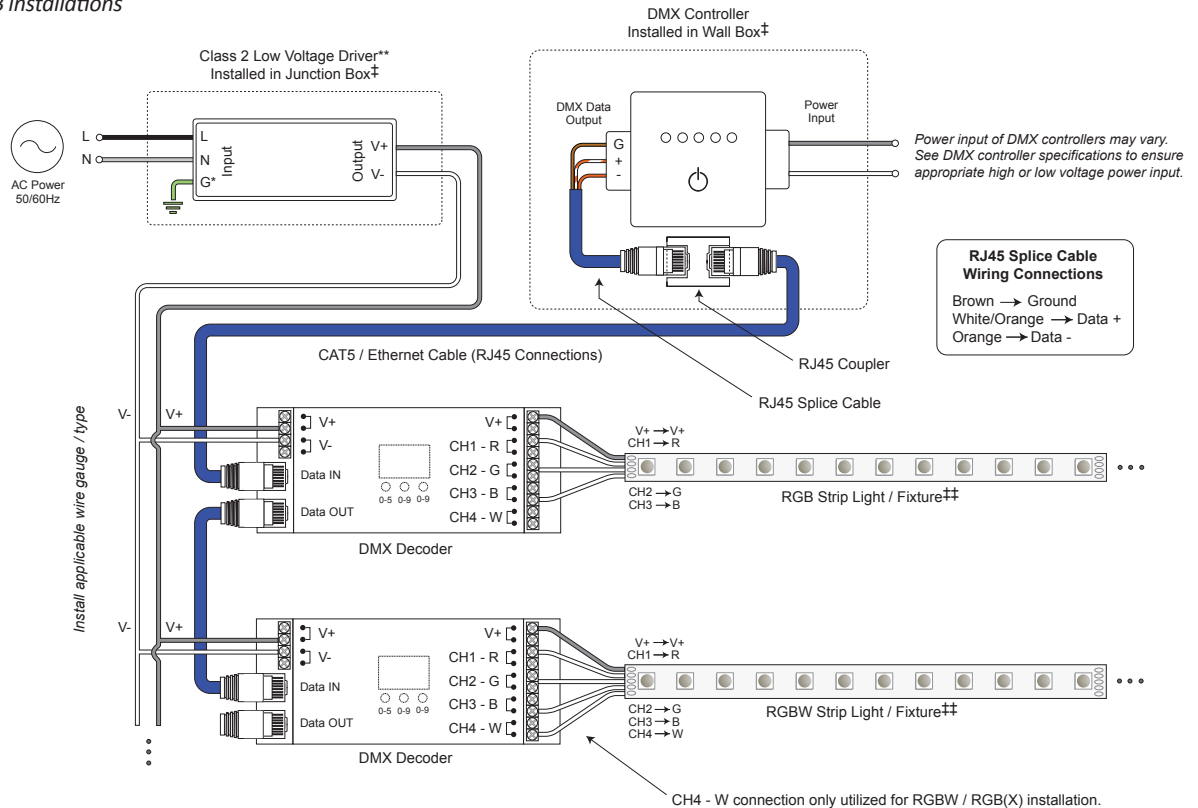

See the last page for technical notes applicable to all system diagrams.

System Diagram Technical Notes

* Driver may not require a fault ground connection. Refer to driver specifications for additional information.

*** Install a Class 2 constant voltage driver compatible with a low voltage PWM controller/dimmer switch. Refer to each driver specification sheet for full power ratings & load deratings.

**** Determine the number of low voltage outputs of the driver when installing multiple PWM controllers/dimmer switches. No more than one PWM controller/dimmer switch can be attached to a single output of the driver.

‡ Refer to driver or controller specifications for a compatible junction box.

‡‡ See fixture specifications for maximum series run limits.

§ See in-line accessories specifications for maximum amperage ratings.

Troubleshooting

Prior to troubleshooting, ensure all items are a compatible system and main power is turned ON.

Shift in brightness and/or color

Review maximum series run limits. Exceeding these limits will cause excess voltage drop, decreasing brightness and/or color as the run is extended.

Some LEDs are not functional

Ensure all connections have been properly attached. Ensure fixture has not been bent excessively, which may cause components and solder to detach from the circuit board.

Lights are flickering

Ensure a compatible driver is installed. Ensure the pre-set mode of the color controller is not on a dynamic mode. Ensure Data +/- connections of DMX systems are not reversed. If lights continue to flicker, check for loose connections. Ensure tape light connectors are properly attached.

Lights are turning on/off repeatedly

Ensure driver is not overloaded. An overloaded driver will trip the internal auto-reset (of driver) repeatedly, turning the system on/off.

CLICKTIGHT Connector Troubleshooting

- Ensure compatible CLICKTIGHT models are attached. Tape lights vary in width and require specific connectors. Contact your supplier for additional information.
- Tape light is polarity sensitive. Ensure the +/- markings of the CLICKTIGHT connector is aligned with the +/- markings of the tape. If polarity is backwards, reverse the lead wire connection or detach tape from CLICKTIGHT connector and reattach opposing end of tape to connector.
- If connection is not secure, pull tape out from the CLICKTIGHT connector and trim any excess tape so the outer edges of contact/solder points are flush with the end of the tape (see below). Insert trimmed end back into CLICKTIGHT connector with the 3M adhesive backing still in tact to tape.

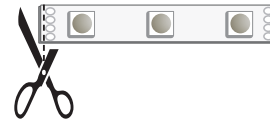

Rev 2.2, 1/7/13

For additional troubleshooting information see the individual component installation guides. For additional questions and concerns regarding installation, contact technical support. Please have all product part numbers on hand for fast and efficient technical assistance.